

# Luna Discretion Series

Full Model

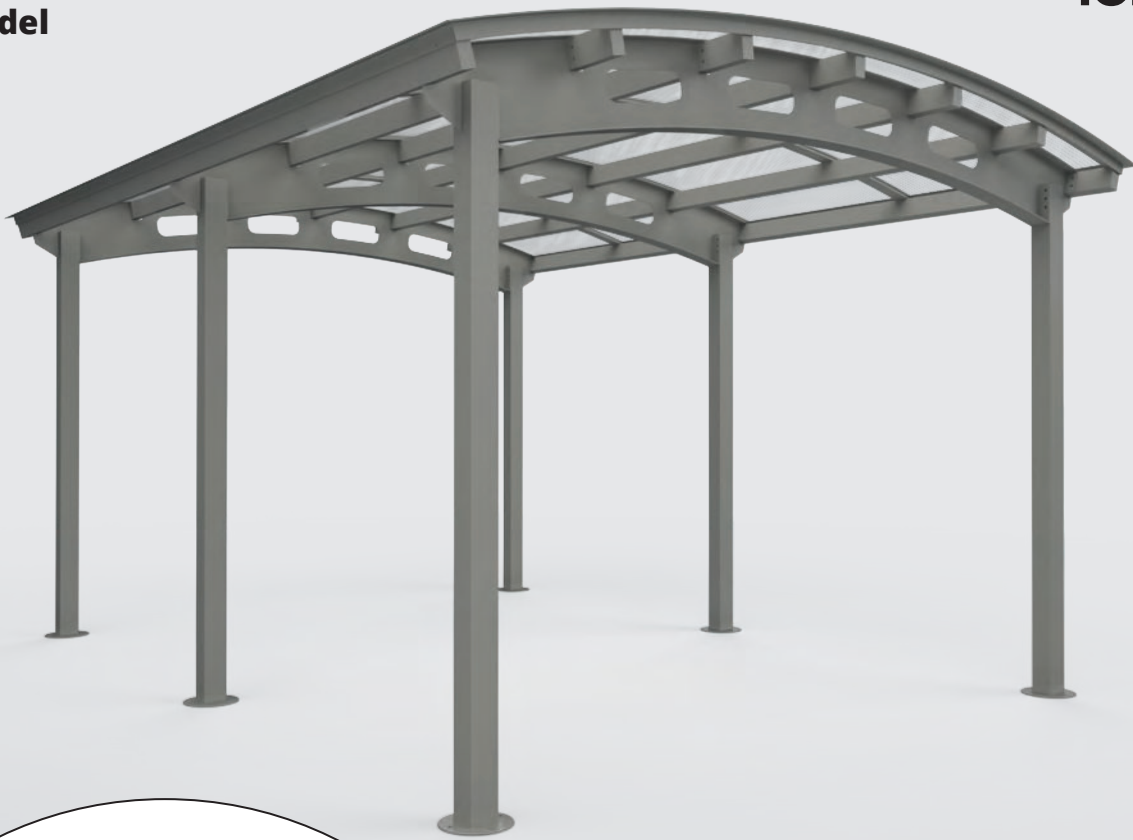

**Specialized in Custom Design**

**Solid steel and aluminum structure**

**Load-bearing capacity to withstand the worst weather conditions**

**Curved roof with customized pitch**

**Maximum clearance between posts**

Standard colours

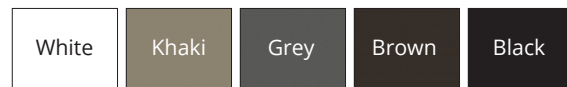

6061-T6 aluminum frame (3/16-inch thick)

Baked paint quality certified AAMA 2603, AAMA 2604 (on request)

Stainless steel or galvanized hardware (optional anti-theft)

Mechanical anchors (optional chemical anchors)

16 mm RDC polycarbonate roof with UV protection and 0.57 shading coefficient (standard)

44W steel arch

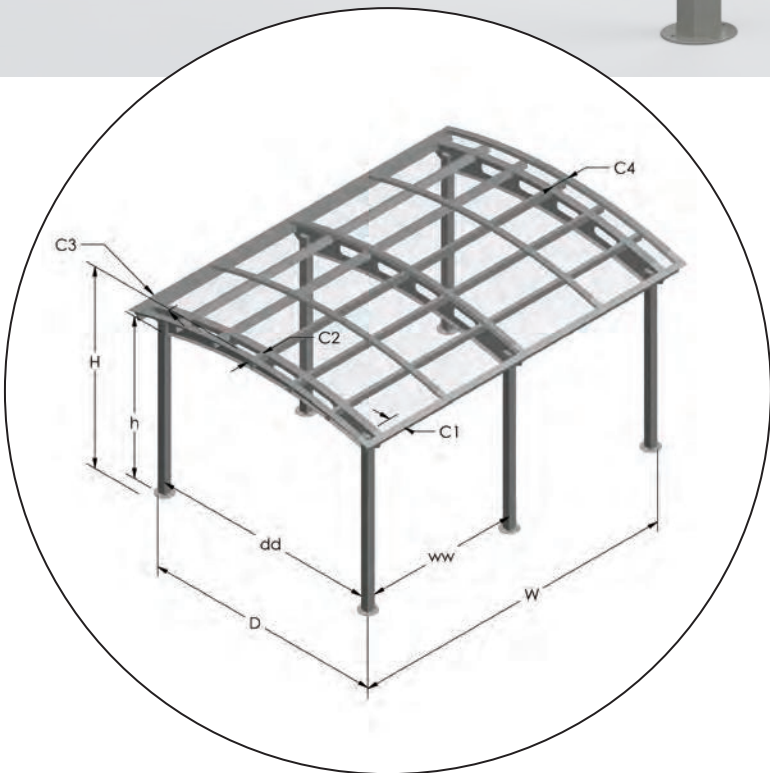

Roofing options			Dimensions												
Polycarbonate	Corrugated sheet metal	Wood and sheet metal	ww	h	H	S	W	dd	D	Front posts	Back posts	C1	C2	C3	C4
x	-	-	Max 144	Std 80	3:12	-	Max ∞	Max 480	Max ∞	Std 4 x 4 x 3/16	-	8	8	8	8

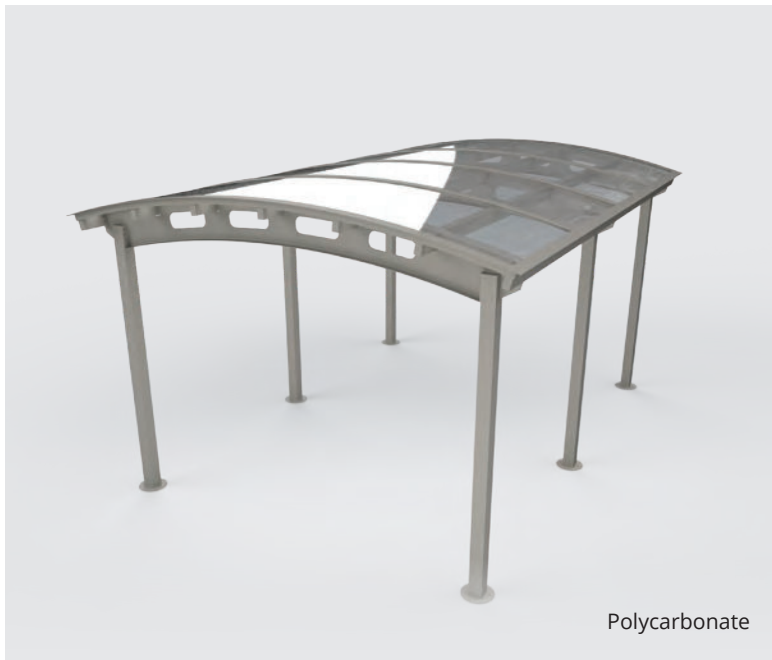

Polycarbonate

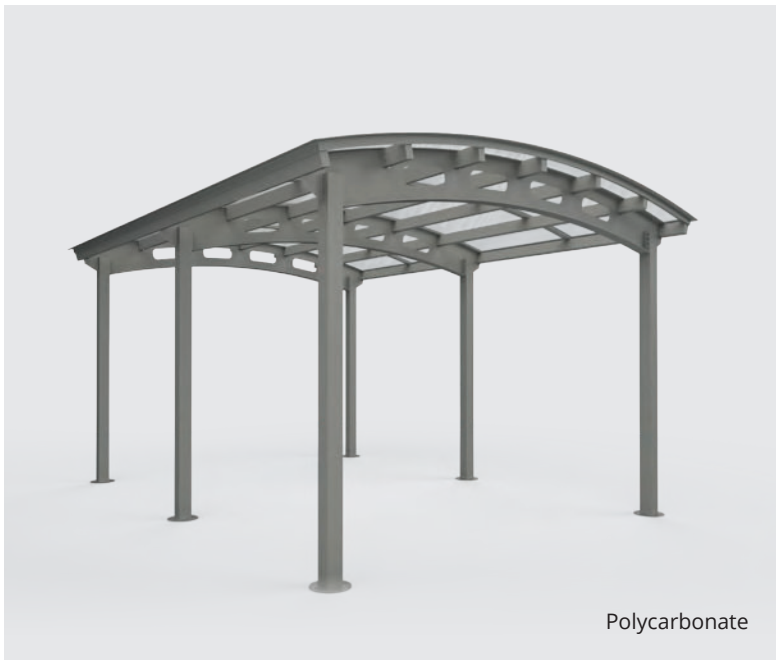

Polycarbonate



Aluminum and glass wall



Privacy panel

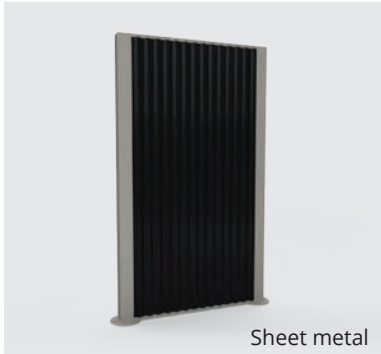

Sheet metal

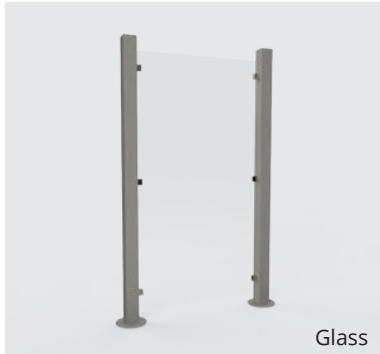

Glass

## Wall options

### Glass

6 mm on clips for maximum ventilation

### Panels with watertight frame

Several finish options for watertight frame: sheet metal, sheet metal and wood, glass, solid or perforated aluminum panels, and more

### Privacy panel

Choice of 17 standard models or custom-made

### Combination of options

E.g., an aluminum and glass wall

Also available are our doors, windows, sliding doors and 3-season fixed panels. Doors have the same finish options as walls.